



Technical Data

MIRROR WITH STAINLESS STEEL CHANNEL FRAME

B-165 SERIES

SNAP LOCKING DESIGN (Rear View)

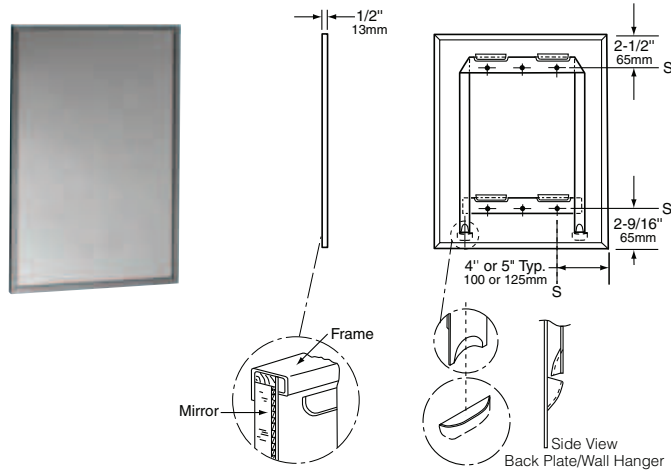

Figure: 1

SCREW LOCKING DESIGN (Rear View)

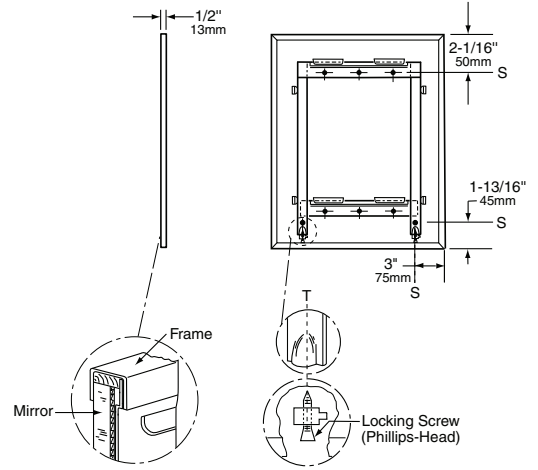

Figure: 2

STANDARD B-165 SERIES MIRRORS

MODEL NO.	OVERALL SIZE	
	W	H
B-165 1824	18" (46cm)	24" (61cm)
B-165 1830	18" (46cm)	30" (76cm)
B-165 1836	18" (46cm)	36" (91cm)
B-165 2430	24" (61cm)	30" (76cm)
B-165 2436	24" (61cm)	36" (91cm)
B-165 2448	24" (61cm)	48" (122cm)
B-165 2460	24" (61cm)	60" (152cm)

STANDARD B-165 SERIES MIRRORS

MODEL NO.	OVERALL SIZE	
	W	H
B-165 4836	48" (122cm)	36" (91cm)

All Other Size Mirrors

Designer's Notes:

1. Special-order sizes available on request.
2. Maximum size mirror available, 72" x 60" (183 x 152cm); minimum size, 12" x 12" (30 x 30cm).
3. All Bobrick framed mirrors are manufactured to overall width and height dimensions. EXAMPLE: A 24" x 36" (61 x 91cm) mirror will be furnished 24" x 36" (61 x 91cm) outside-of-frame to outside-of-frame.
4. To specify special sizes use Series Number followed by width then height in inches. EXAMPLE: B-165 2024.
5. Bobrick framed mirrors are manufactured to a tolerance 1/8" (3.2mm).
6. For sufficient space to lift mirror onto wall hanger(s), provide 3-1/4" (85mm) minimum clearance above center line of mounting screw holes.
7. Provide 1" (25mm) minimum clearance at bottom of mirror for engaging locking screws and 1" (25mm) clearance on each side.

MATERIALS:

Frame — Type-430 stainless steel, 1/2" x 1/2" x 3/8" (13 x 13 x 9.5mm) channel with 1/4" (6mm) return at rear with bright polished finish. One piece frame with 90 degree mitered corners. Galvanized steel back has integral horizontal hanging brackets near the top for hanging the mirror and near the bottom to prevent the bottom of the mirror from pulling away from the wall. Locking devices secure mirror to concealed wall hanger. In Screw Locking Design (see figure 2), concealed Phillips-head locking screws securely fasten mirror to wall hanger.

Mirror — No. 1 quality, 1/4" (6mm) select float glass: selected for silvering, electrolytically copper-plated by the galvanic process, and guaranteed for 10 years against silver spoilage. Corners are protected by friction-absorbing filler strips; back is protected by full-size, shock-absorbing, water-resistant, nonabrasive, 3/16" (5mm) thick polyethylene padding.

Concealed Wall Hanger — 20-gauge (0.9mm) galvanized steel. Incorporates lower support member, forming rigid rectangle, which engages lower backplate louvers to keep bottom of mirror against wall.

continued . . .

INSTALLATION:

Mount wall hanger on wall with screws (not furnished) at points indicated by an S. For plaster or dry wall construction, provide backing to comply with local building codes, then secure wall hanger with screws (not furnished). When providing a concealed backing, allow backing to cover minimum range of mounting hole locations shown on drawing. For other wall surfaces, provide fiber plugs or expansion shields for use with screws (not furnished), or provide 1/8" (3mm) toggle bolts or expansion bolts. Hang mirror on wall hanger with all four backplate louvers engaged behind horizontal wall hanger members. Hang mirror on wall hanger with all four backplate louvers engaged behind horizontal wall hanger members. To do this, mirror must be centered in front of the wall hanger horizontally, pressed flat against the wall approximately 1" (25mm) above final position and then lowered into final position.

Snap Locking Design — Locking devices automatically secure mirror to concealed wall hanger when it is lowered into final position. Locking devices may be unlocked by inserting two flat blade screwdrivers behind each side of mirror near the bottom or under the bottom of the mirror and pulling mirror bottom forward and then up (see figure 3).

Screw Locking Design — Lock mirror to wall hanger by tightening Phillips-head locking screws that are concealed in the bottom of frame at points indicated by a T. Mirror may be unlocked from wall hanger by loosening locking screws and lifting mirror off of concealed wall hanger (see figure 4).

SNAP LOCKING DESIGN
(Front View)

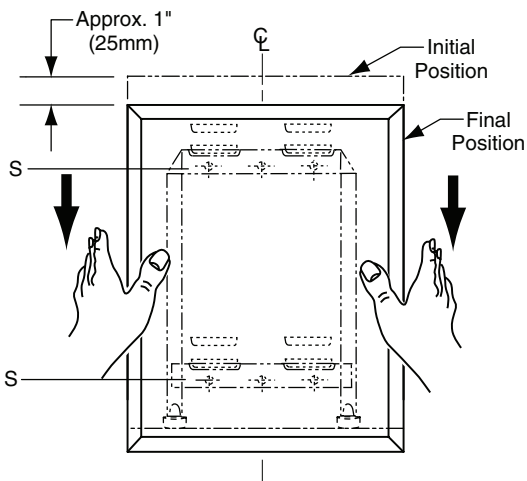

Figure: 3

SCREW LOCKING DESIGN
(Front View)

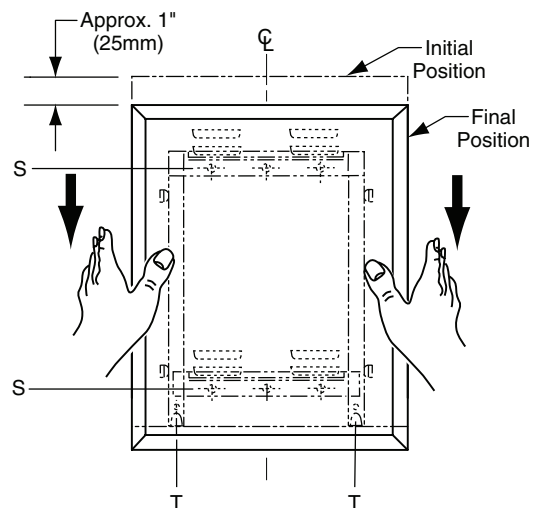

Figure: 4

SPECIFICATION:

Mirror shall have a one-piece type-430 stainless steel channel frame, 1/2" x 1/2" x 3/8" (13 x 13 x 9.5mm), with 90° mitered corners; all exposed surfaces shall have bright polished finish. Select float glass mirror shall be guaranteed for 10 years against silver spoilage. Corners shall be protected by friction-absorbing filler strips and the back shall be protected by full-size, shock-absorbing, water-resistant, nonabrasive, 3/16" (5mm) thick polyethylene padding. Galvanized steel back shall have integral horizontal hanging brackets located at top and bottom for mounting on concealed rectangular wall hanger to prevent the mirror from pulling away from the wall. Locking devices secure mirror to concealed wall hanger. Mirror shall be removable from the wall.

Framed Mirror shall be Model B-165 _____ (insert width and height) of Bobrick Washroom Equipment, Inc., Clifton Park, New York; Jackson, Tennessee; Los Angeles, California; Bobrick Washroom Equipment Company, Scarborough, Ontario; Bobrick Washroom Equipment Pty. Ltd., Australia; and Bobrick Washroom Equipment Limited, United Kingdom.